

# Web51 – Design KIT board v. 3.2

## Hardware documentation

Web51 is project of connecting an Intel x51 compatible processor to the Realtek RTL8019AS ethernet network controller. This datasheet is the hardware documentation for one of the physical solution compatible with Web51 development system.

### Basic description

The **Design KIT board v. 3.2** is one of the possible HW solutions for the Web51 project. This board is intended for demonstration of how easy is the implementation of an Ethernet interface with an x51 MPU. For easy usage and modifications of the HW, the entire board is designed using standard packages with only the necessary components in SMD. This board is freely available in .SCH and .BRD for the CadSoft EAGLE program.

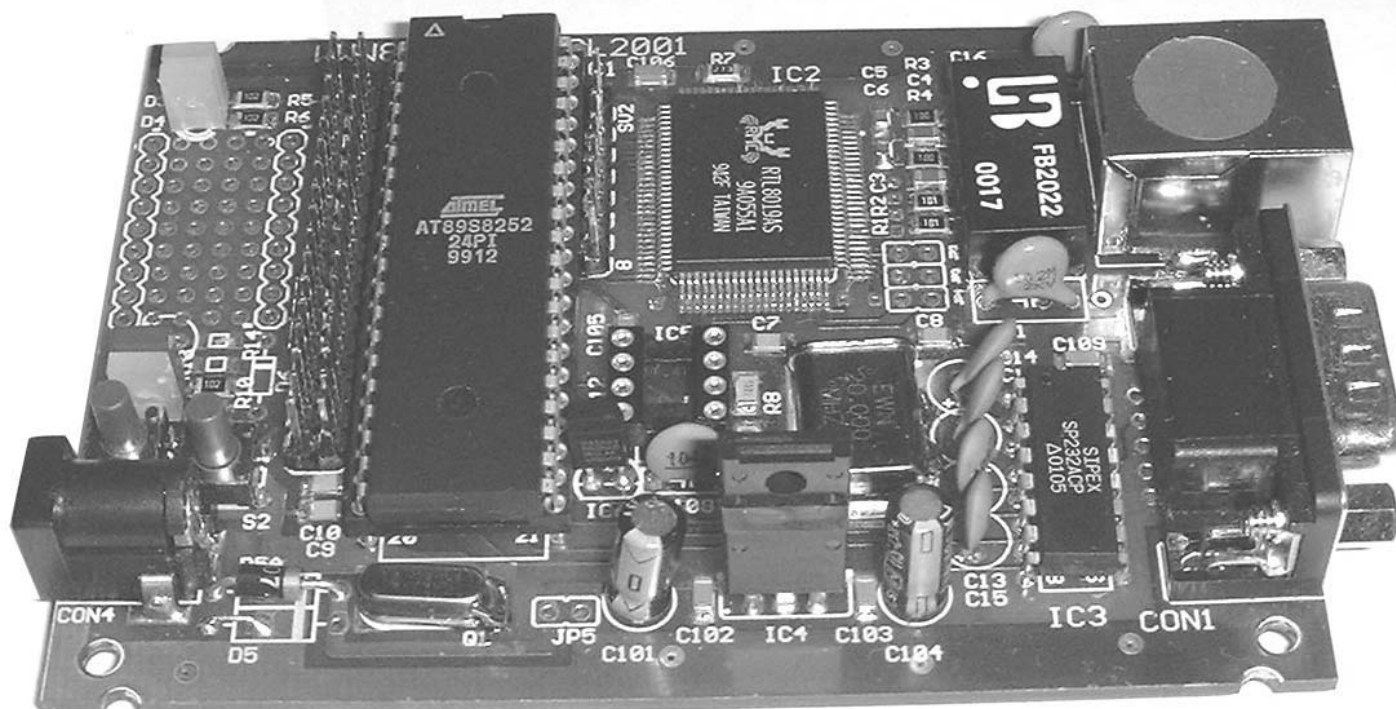

Since 01.09.2002 the delivery includes a RD2 CPU and a light I/O controller application!

Without any more programming you can use:

- WWW and TELNET remote control of 8 TTL Inputs and Outputs.
- Easy remote access to the serial port.
- LCD display supported, Text controlled via WWW and Telnet...

2999 Kč / \$120

Page 1 of 9

## Basic characteristics of this HW implementation

---

- Free printed circuit board design in CadSoft EAGLE software, downloadable as a.BRD file.
- Intel x51 compatible CPU in DIL400 – clones are produced by a number of manufacturers (Analog Devices, Atmel, Cygnal, Dallas, Intel, ISSI, SMC, Philips, Siemens/Infineon, Windbond.)
- Full-duplex IEEE 802.3 Ethernet controller, data flow indication, RJ45 connector on the PCB.
- **Ethernet Controller RTL8019AS is connected to P0 and P2 in the port mode.** You can use these ports for generating the MOVX or MOVC address space, but you'll need external latch 74573 and pin P2.7 (A15) to enable RTL8019. (No PSEN and ALE available on PFL34)
- RAM, ROM and EEPROM are all inside the CPU.  
RAM can be extended with an optional memory module that plugs into a connector on the PCB.
  - **AT89S8252** = 256 B RAM / 8 kB FLASH / 2 kB EEPROM
  - **T89C51RD2** = 1280 B RAM / 64 kB FLASH / 2 kB EEPROM
- Internal CPU watchdog and external reset controller for higher reliability and robustness.
- 16 I/O wires (entire port P1, part of P3, two pins of P2). Ready for SW-controlled I<sup>2</sup>C.
- CPU (8252 or RD2) can be ISP programmed. (8252 through 5 wires available on the PFL34 connector, RD2 through the serial RS232 line).
- DESIGN version of the KIT contains on the PCB a small universal area for simple peripherals and two LEDs and two buttons for simple control and indication.
- Coaxial connector for DC 9-18V power (standard version has **Vcc** on the inside and **GND** on the outside contact). You can change this by swapping D5a and wire connection on the D5 position.
- Serial RS 232 port on a Cannon 9-pin connector, to connect to a PC serial port (contains signals RxD, TxD, CTS, RST, GND).

**IMPORTANT:** *There is a bug on some pieces of the HW implementations of v3.2. Illogically, a female cannon 9 connector is used with a male pinout. Please check the table on the connections page.*

Design KIT board v. 3.2 – Connections

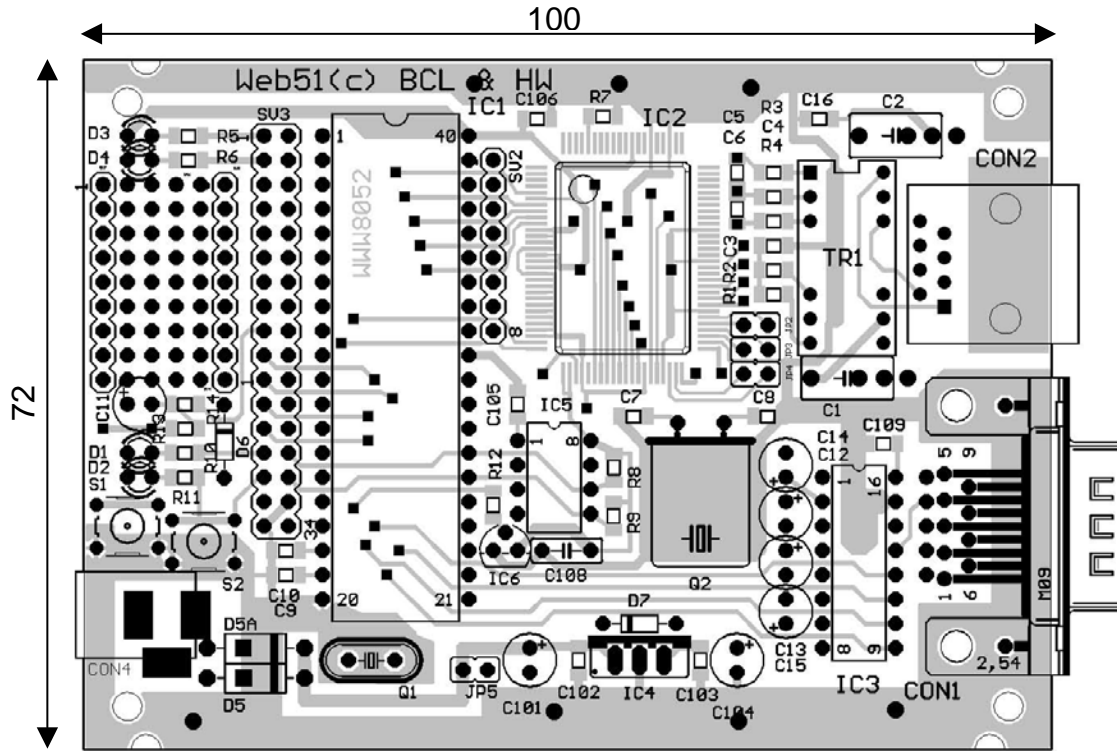

SV3 (PFL 34) :

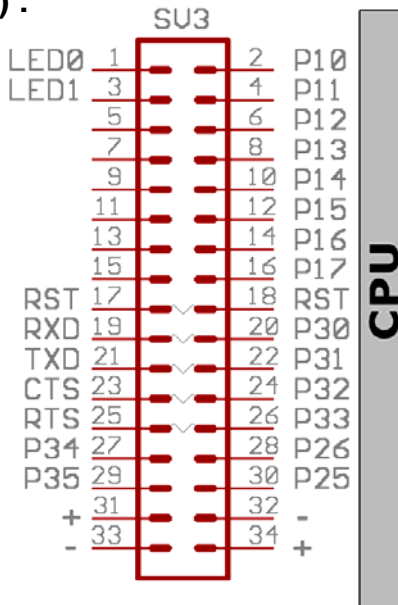

ETHERNET (RJ45) :

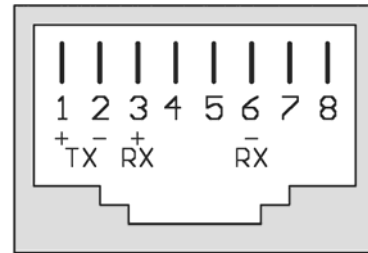

RS232 (CAN9M) :

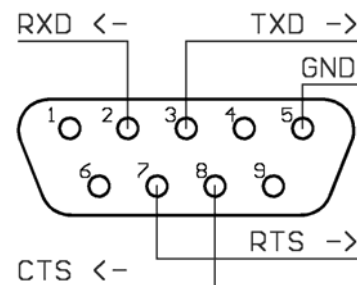

Cannon 9 – Female	Cannon 9 – Male	Connection
1	5	--- <b>GND</b> (connect to pin 5 – gnd from PC)
3	3	--> <b>TxD</b> (connect to pin 2 - RxD from PC)
4	2	<-- <b>RxD</b> (connect to pin 3 - TxD from PC)
7	8	<-- <b>CTS</b> (connect to pin 7 - RTS from PC)
8	7	--> <b>RTS</b> (connect to pin 8 – CTS from PC)

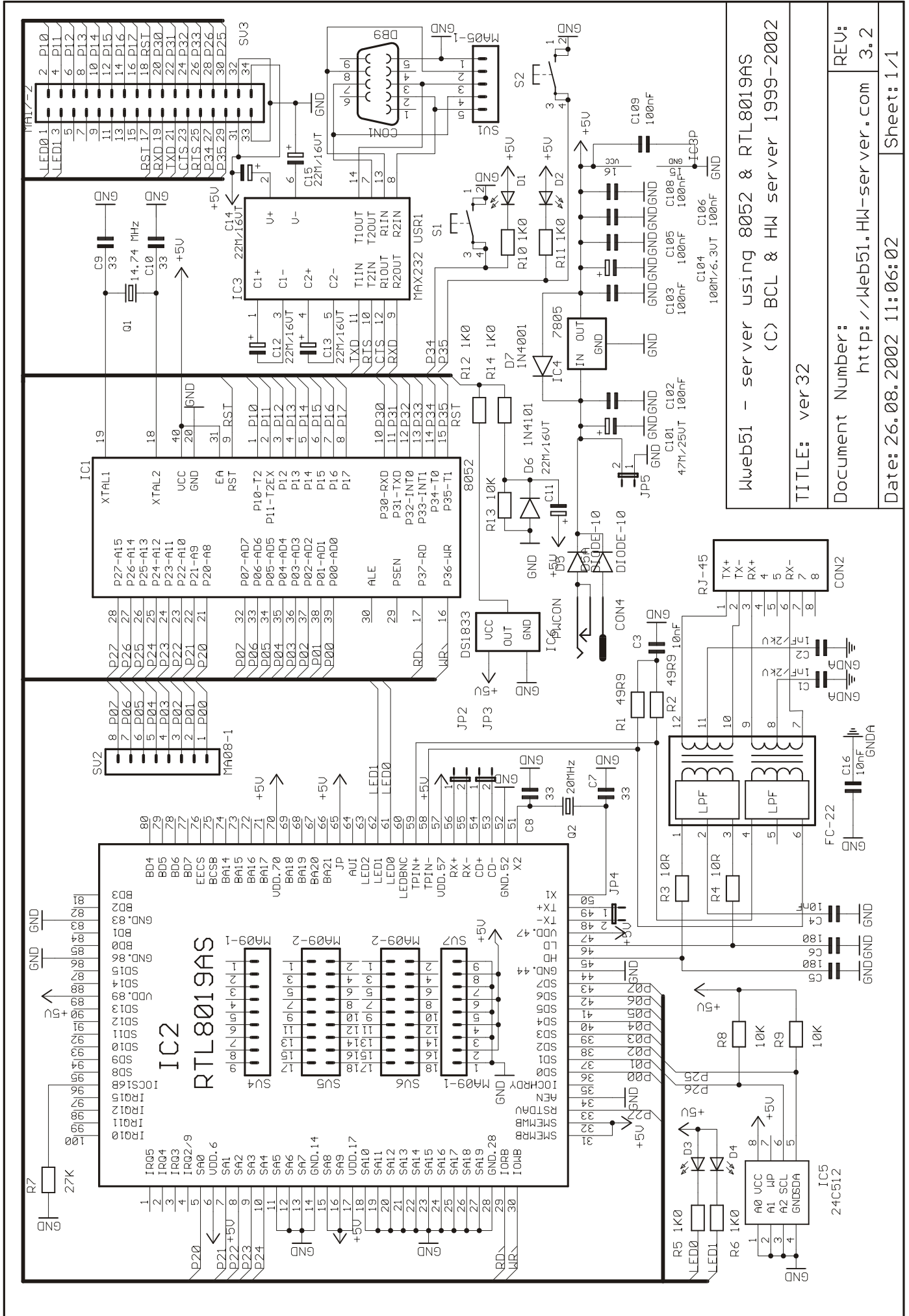

Wweb51 – server using 8052 & RTL8019AS  
 (C) BCL & HW server 1999-2002  
 TITLE: ver32  
 Document Number: http://web51.HW-server.com  
 REV: 3.2  
 Date: 26.08.2002 11:06:02  
 Sheet: 1/1

## PCB – top (components) side

---

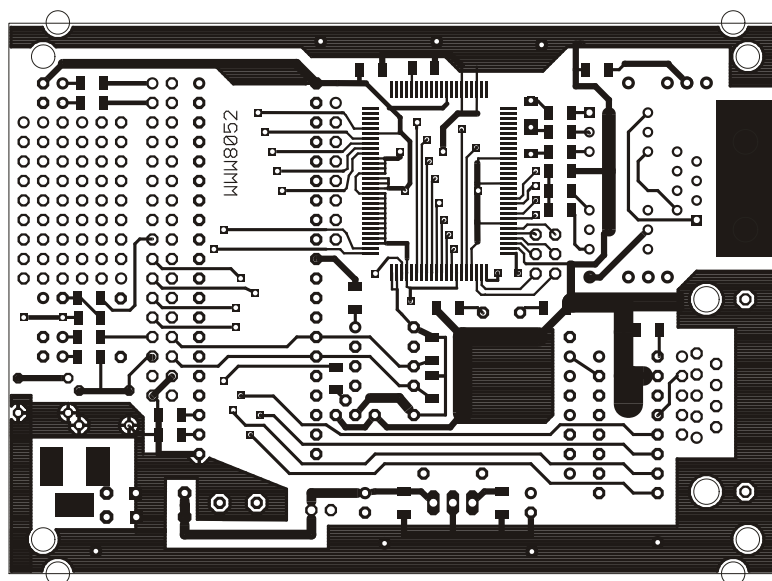

## PCB – bottom side

---

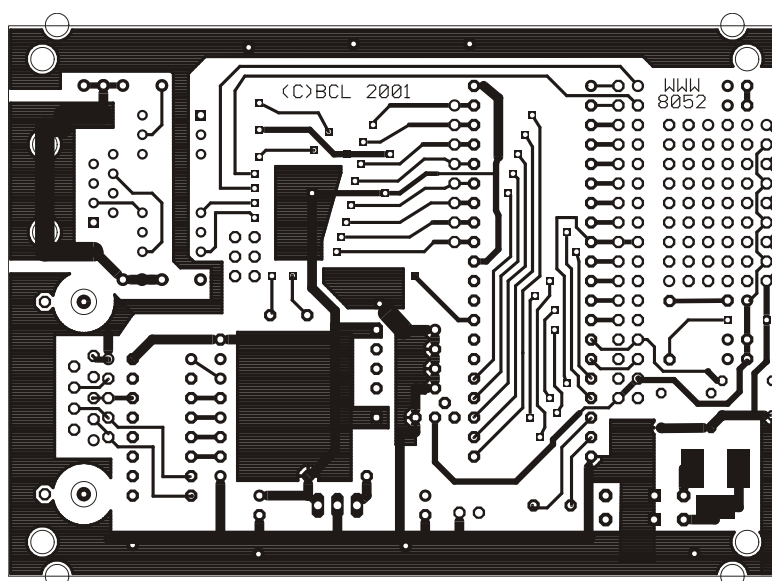

## Free downloadable .BRD file

---

This board was designed using the EAGLE PCB design program by CadSoft – [www.cadsoft.de](http://www.cadsoft.de), you can download .brd file free of charge on the download page of the web51 project.

## Basic characteristics of the Web51 project software

---

- All Web51 software is written in assembler, C version is in preparation (October 2002).
- Use of high-level language (such as C) is limited by 256B of internal RAM on the CPU on this hardware (for T89c51RD2 1280 bytes). If the RAM is expanded, a C compiler (e.g. Keil) can be used with the full version of the libraries.
- Web51 development system can be used under almost any OS. Most utilities needed for compiling and other tasks are available in most operating systems. The development system directly supports DOS32 (MS-DOS with 32-bit support, Windows) and Linux.
- Software for such a large project must be split into many parts. Compiling and linking into the single final file is controlled by the make utility. Compilation process is detailed in the SW documentation in the chapter “Compiling with Makefile”.
- The GNU assembler mcs51-as from the binutils package is used to compile .ASM into .OBJ. The original assembler supports many processors, such as I96, I86, and HC12... We have added support for I51. The assembler is a part of the free distribution since version 1.12.
- Resulting .OBJ files are linked with mcs51-ld, again a modified version from the binutils.
- In some cases, bash – command interpreter – is useful for compiling. However, it is possible to compile in the DOS32 or WinXX command line.

## Examples of applications

---

- Simple controlling of devices operating over TCP/IP...
- Communication module for your instruments, acting as an Internet gateway...
- Interface that can be programmed to handle any protocol...
- Collecting and sharing of data over a network...
- Extension of a RS 232/422/485 serial port...
- Connection of common appliances to a computer network...

## Web51 distributions

---

### Web51 is an open system. You can use it in many ways:

- Get inspired by the free code and build your own application on **your own HW and SW**.
- Purchase our development system with the development kit, design your own hardware and build **your own HW application**.
- Purchase just the HW of our development kit (approx. \$25 - \$100), use the free version, order the HW of the design kit and build **your own application**.
- Base your application on our FINAL APPLICATIONS (turn-key solution), and concentrate only on the **HW of special peripherals**. We may guarantee long-term supply of modules etc.
- **Need a turnkey solution?** Do you need for example any improvements on our I/O Controller? No problem, we can make a custom design - ask for details – [Web51@hw.cz](mailto:Web51@hw.cz).

## Our design products for the Web51 system

### Design KIT

HW and SW development KIT based on Web51 technology. Contains a Web51 KIT with the T89C51RD2 microcontroller and a CD ROM containing everything from our Ethernet CD as well as the source code of the library. The library is subject to the commercial license and can be redistributed in binary form only. The KIT also includes our development environment for Windows and Linux, unique MAC address and a printed manual. The Design KIT further includes a pre-paid royalty and a commercial license for the use of the Web51 system.

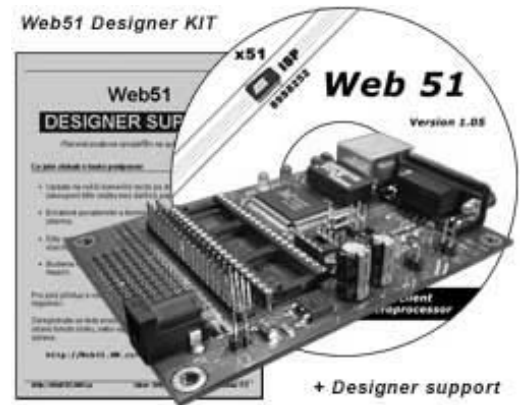

### Designer support

Designer support is a service that ensures updates for 18 months for no extra cost, training and literature discounts, and other advantages. If requested, we can also grant you another batch of MAC addresses and waived royalties with purchase.

**Web51 Designer KIT – 5.500 Kc - \$280**  
**Web51 Designer KIT + D. Supp. – 6.800 Kc - \$315**

### Web51 - SW & License

Software of the Web51 system under a commercial license.

- CD with complete docs, source codes, PDF and HTML manuals
- Commercial license without GNU GPL limitations
- Assembler, linker, programming utilities, development environment
- Firmware supports sending e-mails (starting from version 1.14)



To speed up the delivery, you can request to have the basic sources delivered by e-mail. This way, you don't have to wait for the CD and printed license.

**Price – 4.000 Kc - \$220**

## Our HW products for the Web51 system

### Web51 HW KIT – version 3.68

Simplified hardware designed for initial familiarization with the features of a small Web server. Complete documentation is available on the project web pages. In this simplified kit, the Ethernet controller RTL8019AS is connected to 16 pins of an x51 compatible controller in DIL package. A fully functional WWW server that responds to Echo requests and serves HTML pages or a telnet server to remote access for the serial port.

All published examples work with this hardware and can be loaded and run right away (such as I/O control, simple temperature measurement, LCD interface, TELNET access to serial port over a TCP/IP network, and more).

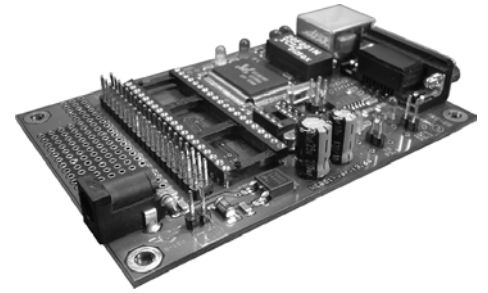

**Price – 3.200 Kc / \$170**

### Web51 HW – version 4.x

Industrial version designed with respect for EMC etc. Wiring is similar to version 3.x = only internal RAM and FLASH of MCU. Most final Ethernet applications - serial converters and I/O controllers – are based on this hardware.

Optional add-ons, such as a metal box, RS485 module, fixing utilities, etc. are available. This hardware is fully compatible with the Web51 development system.

There are optocouplers and relays for industrial usage, schematic is included in the documentation of this HW version.

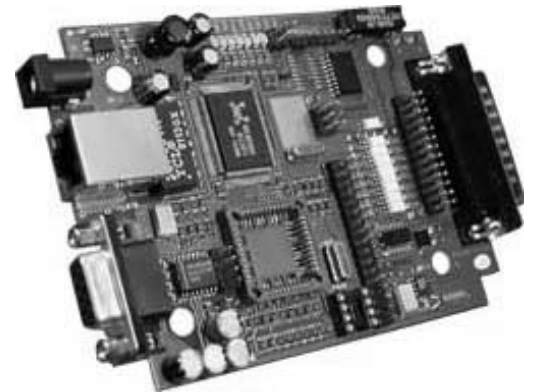

**Price – 3.900 Kc / \$210**

### Web51 HW – version 5.x

Industrial version designed with respect for EMC with 32 kB RAM and 512 kB FLASH. Compatible with Web51 development system starting with version 1.15 for the ASM version and version 2.0 for the C version. There are only 3 optocouplers on inputs and 2 relays but all additional peripheral are expandable via extension modules.

Optional add-ons, such as a metal box, RS485 module, fixing utilities, etc. are available.



**Price – 4.500 Kc / \$210**

### Web51 HW – version 6.x and 7.x (modules)

Ver. 6.x – Rabbit RCM2200 compatible module – Price \$50 / 1 qty. - \$40 / qty. 100

Ver. 7.x – Remote TTL Serial port and I/O controller – Price \$65 / 1 qty. - \$55 / qty. 100

- Both version available starting 10.10.2002



## Final application products for the Web51 system

---

### ETHERNET-RS232 converter

Converts the serial line to an Ethernet connection and vice versa; supports RS485 communication. TCP/IP and UDP/IP supported on the Ethernet side. Devices may communicate with each other or with a computer (server or workstation). Can be used as a buffer for collecting data from a serial port, to remotely control a technological process, or for remote attachment of peripherals.



Support includes device control subroutines for a wide range of programming languages and operating systems. More details upon request or in the pricelist...

### ETHERNET I/O Controller

Allows remote control and monitoring of up to 24 inputs and outputs, or, for example, to measure temperature. Monitoring and control is managed by an authorized WWW interface, Telnet with the option to establish connection upon input changes, or by e-mail.



**ETHERNET I/O Controller**

Typical applications include an intelligent watchdog controlled over a network that can buffer and send reports of performed operations or changes of inputs. For the I/O controller, a library supported in several visualization and control software is available.

Without any PC, this device can, for example, make a PBX or a security panel accessible over the Ethernet, turns on or off any appliance, or sends you an email saying, "A mouse is in the mouse trap, remove it and add more cheese"... More details upon request or in the pricelist...

## Links & More information

---

This datasheet and more documentation is available on the Web51 download page accessible at <http://Web51.HW-server.com> -> **DOWNLOAD PAGE**

- More information about Web51 project management and SW documentations are available in the **web51\_introduction.pdf** - „Web51 – Basic development manual“.
- Web51 products can be purchased with a Credit Card or via Wire Transfers. Detailed ordering information is available for download in the **pricelist.pdf**.
- Web51 licensing strategy is described in detail in these two files:
  - Web51 Project – „Commercial licence“ - **web51\_licence\_commercial.pdf**
  - Web51 Project – „Free version licence“ - **web51\_licence\_free.pdf**
- Our complete products list – “HW pricelist“ - **hw\_productlist.pdf**